



ED-HMI3020-070C

**7-inch High-Performance Industrial
Panel PC Based on Raspberry Pi 5**

User Manual

EDA Technology Co., LTD

March 2024

Contact Us

Thank you very much for purchasing and using our products, and we will serve you wholeheartedly.

As one of the global design partners of Raspberry Pi, we are committed to providing hardware solutions for IOT, industrial control, automation, green energy and artificial intelligence based on Raspberry Pi technology platform.

You can contact us in the following ways:

EDA Technology Co.,LTD

Address: Building 29, No.1661 Jialuo Road, Jiading District, Shanghai

Mail: sales@edatec.cn

Phone: +86-18217351262

Website: <https://www.edatec.cn>

Technical Support:

Mail: support@edatec.cn

Phone: +86-18627838895

Wechat: zzw_1998-

Copyright Statement

ED-HMI3020-070C and its related intellectual property rights are owned by EDA Technology Co.,LTD.

EDA Technology Co.,LTD owns the copyright of this document and reserves all rights. Without the written permission of EDA Technology Co.,LTD, no part of this document may be modified, distributed or copied in any way or form.

Disclaimer

EDA Technology Co.,LTD does not guarantee that the information in this manual is up to date, correct, complete or of high quality. EDA Technology Co.,LTD also does not guarantee the further use of this information. If the material or non-material related losses are caused by using or not using the information in this manual, or by using incorrect or incomplete information, as long as it is not proved that it is the intention or negligence of EDA Technology Co.,LTD, the liability claim for EDA Technology Co.,LTD can be exempted. EDA Technology Co.,LTD expressly reserves the right to modify or supplement the contents or part of this manual without special notice.

Foreword

Related Manuals

All kinds of product documents contained in the product are shown in the following table, and users can choose to view the corresponding documents according to their needs.

Documents	Instruction
ED-HMI3020-070C Datasheet	This document introduces the product features, software and hardware specifications, dimensions and ordering code of ED-HMI3020-070C to help users understand the overall system parameters of the products.
ED-HMI3020-070C User Manual	This document introduces the appearance, installation, startup and configuration of ED-HMI3020-070C to help users use the product better.
ED-HMI3020-070C Application Guide	This document introduces downloading OS file, flashing to SD card, Firmware Update, and Configuring booting from SSD of ED-HMI3020-070C to help users use the product better.

Users can visit the following website for more information:

<https://www.edatec.cn>



Reader Scope

This manual is applicable to the following readers:

- ◆ Mechanical Engineer
- ◆ Electrical Engineer
- ◆ Software Engineer
- ◆ System Engineer

Related Agreement

Symbolic Convention

Symbolic	Instruction
	Prompt symbols, indicating important features or operations.
	Notice symbols, which may cause personal injury, system damage, or signal interruption/loss.
	Warning symbols, which may cause great harm to people.

Safety Instructions

- ◆ This product should be used in an environment that meets the requirements of design specifications, otherwise it may cause failure, and functional abnormality or component damage caused by non-compliance with relevant regulations are not within the product quality assurance scope.
- ◆ Our company will not bear any legal responsibility for personal safety accidents and property losses caused by illegal operation of products.
- ◆ Please do not modify the equipment without permission, which may cause equipment failure.
- ◆ When installing equipment, it is necessary to fix the equipment to prevent it from falling.
- ◆ If the equipment is equipped with an antenna, please keep a distance of at least 20cm from the equipment during use.
- ◆ Do not use liquid cleaning equipment, and keep away from liquids and flammable materials.
- ◆ This product is only supported for indoor use.

Content

Foreword	i
Related Manuals	i
Reader Scope	i
Related Agreement	ii
Symbolic Convention	ii
Safety Instructions.....	iii
1 Product Description.....	1-1
1.1 Overview.....	1-2
1.2 Packing List	1-3
1.3 Appearance	1-4
1.3.1 Front Panel	1-4
1.3.2 Rear Panel.....	1-4
1.3.3 Side Panel	1-5
1.4 Button	1-7
1.5 Indicator	1-8
1.6 Interface.....	1-9
1.6.1 SD Card Slot.....	1-9
1.6.2 Power Supply.....	1-9
1.6.3 1000M Ethernet	1-9
1.6.4 HDMI	1-10
1.6.5 USB 2.0	1-10
1.6.6 USB 3.0	1-10
1.6.7 RS232.....	1-10
1.6.8 RS485.....	1-11
1.6.9 Audio In	1-12
1.6.10 Audio Out.....	1-12
1.6.11 Speaker	1-12
2 Installing/Removing Components (optional).....	2-1
2.1 Pull Out SD Card	2-2
2.2 Insert SD Card	2-4
2.3 Open Device Case.....	2-6
2.4 Remove SSD	2-8
2.5 Install SSD	2-10
2.6 Install RTC Battery.....	2-12
2.7 Close Device Case	2-14
3 Installing Device	3-1
3.1 Embedded Installation	3-2
4 Booting The Device.....	4-1
4.1 Connecting Cables.....	4-2
4.2 Booting The System For The First Time.....	4-3
5 Configuring System.....	5-1
5.1 Finding Device IP address	5-2

5.1.1	View IP address at the Network icon of Desktop	5-2
5.1.2	Hostname command to query	5-3
5.1.3	Query IP by Using ifconfig Command	5-3
5.1.4	Query IP by Using Network Manager CLI	5-4
5.1.5	Login Router to Query IP	5-4
5.1.6	Scan For Using NMAP Tool	5-5
5.2	Remote Login	5-6
5.2.1	Connect To The Device Via SSH	5-6
5.2.2	Connecting To The Device Desktop Through VNC	5-8
5.3	Configuring Wi-Fi	5-11
5.3.1	Enable Wi-Fi	5-11
5.3.2	Configuring Wi-Fi Connection	5-11
5.4	Configuring Ethernet IP	5-13
5.5	Configuring Bluetooth	5-15
5.6	Configuring Buzzer	5-17
5.7	Configuring RTC	5-18
5.8	Configuring Serial Port	5-19
5.8.1	Installing picocom tool	5-19
5.8.2	Configuring RS232	5-19
5.8.3	Configuring RS485	5-19
5.9	Configuring Audio	5-21
5.9.1	Adjusting The Volume	5-21
5.9.2	Configuring Recording	5-22
5.10	Configuring SSD (optional)	5-24
5.10.1	Creating Partition	5-24
5.10.2	Formatting	5-25
5.10.3	Mounting SSD	5-26

1 Product Description

This chapter introduces the product overview, packing list, appearance, button, indicator and interfaces.

- ✓ Overview
- ✓ Packing List
- ✓ Appearance
- ✓ Button
- ✓ Indicator
- ✓ Interface

1.1 Overview

ED-HMI3020-070C is a 7-inch high-performance industrial panel PC based on Raspberry Pi 5. According to different application scenarios and user needs, different specifications of RAM, SD card and SSD can be selected.

- ◆ 4GB and 8GB RAM are optional
- ◆ 32GB and 64GB SD card are optional
- ◆ 128GB and 256GB SSD are optional

ED-HMI3020-070C provides HDMI, USB 2.0, USB 3.0, RS232, RS485, Audio and Ethernet interfaces, supporting access to the network through Wi-Fi and Ethernet. ED-HMI3020-070C integrates RTC and is mainly used in industrial control and IOT.



1.2 Packing List

- ◆ 1x ED-HMI3020-070C Unit
- ◆ 4 x buckles (including 4xM4*8 screws and 4xM4*16 screws)

1.3 Appearance

Introducing the functions and definitions of interfaces on each panel.

1.3.1 Front Panel

This section introduces functions and definitions of front panel.

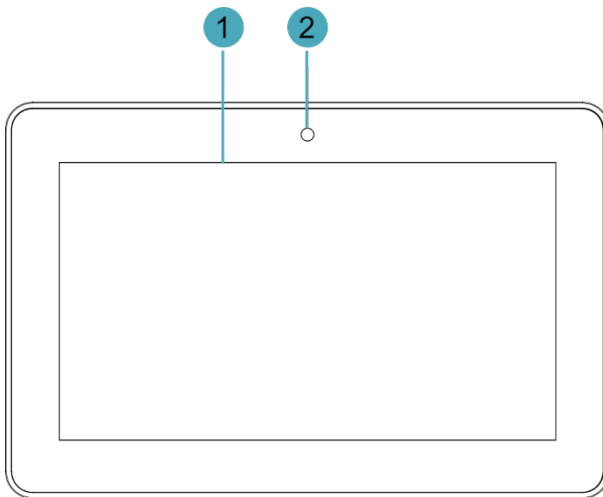

NO.	Function Definition
1	1 x LCD display, 7-inch LCD touch screen, which supports up to 1024x600 resolution and multi-point capacitive touchscreen.
2	1 x camera (optional), 8 Megapixel front camera.

1.3.2 Rear Panel

This section introduces interfaces and definitions of rear panel.

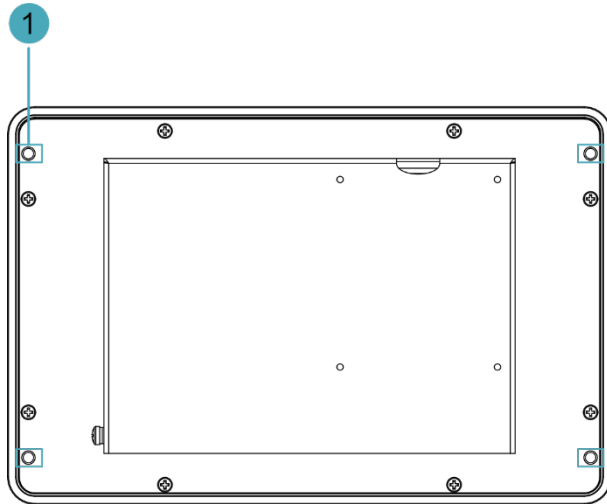

NO.	Function Definition
1	4 x installation holes of buckle, which are used to fix the buckles to the device for installation.

1.3.3 Side Panel

This section introduces interfaces and definitions of side panel.

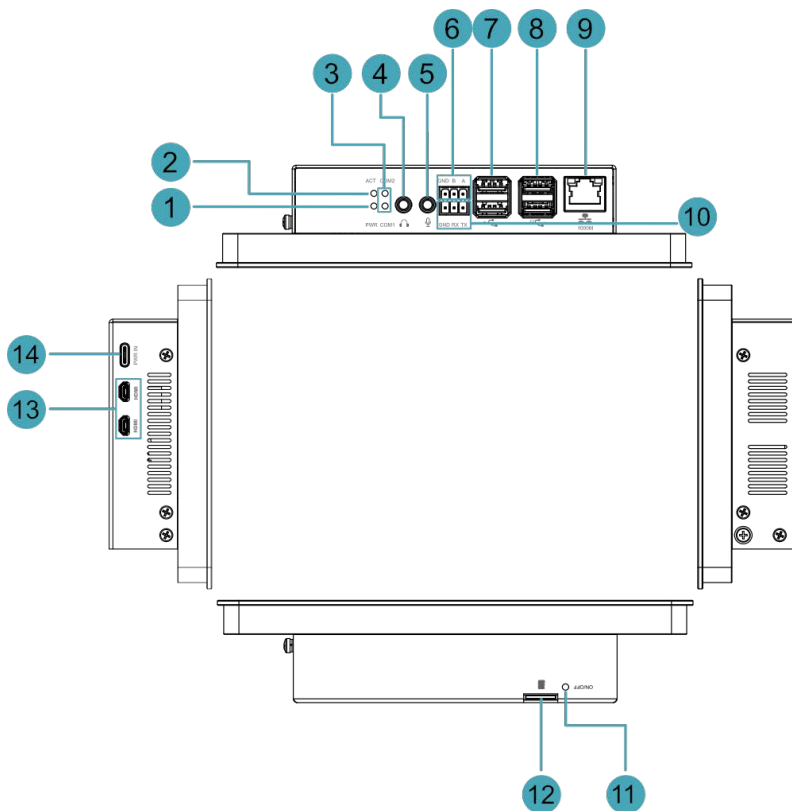

NO.	Function Definition
1	1 x red power indicator, which is used to check the status of device power-on and power-off.
2	1 x green system status indicator, which is used to check the working status of device.
3	2 x green UART indicators, which is used to check the communication status of UART port.
4	1 x Audio Output (HPO), 3.5mm audio jack connector(green), stereo audio output.
5	1 x Audio Input (LINE IN), 3.5mm audio jack connector(red), supporting stereo audio input.
6	1 x RS485 port, 3-Pin 3.5mm spacing phoenix terminal, which is used to connect the third-party control equipment.
7	2 x USB 2.0 ports, type A connector, each channel supports up to 480Mbps.
8	2 x USB 3.0 ports, type A connector, each channel supports up to 5Gbps.
9	1 x 10/100/1000M adaptive ethernet port, RJ45 connector, with led indicator. It can be used to access the network.
10	1 x RS232 port, 3-Pin 3.5mm spacing phoenix terminal, which is used to connect the third-party control equipment.
11	1 x power button, which is used to turn on and turn off the device.
12	1 x Micro SD card slot, which is used to install SD card. It supports booting the OS from SD card.
13	2 x HDMI ports, micro-HDMI connector, which can connect a display and supports 4K 60Hz.
14	1 x DC input, USB Type-C connector, which supports 5V 5A power input.

1.4 Button

The ED-HMI3020-070C includes a ON/OFF button, and the silkscreen is “ON/OFF”. If you run Raspberry Pi Desktop, you can initiate a clean shutdown by briefly pressing the power button. A menu will appear asking whether you want to shutdown, reboot, or logout:



TIP:

If you run Raspberry Pi Desktop, you can press the power button twice in quick succession to shut down.

1.5 Indicator

This section introduces various statuses and meanings of indicators contained in ED-HMI3020-070C.

Indicator	Status	Description
PWR	On	The device has been powered on.
	Blink	Power supply of the device is abnormal, please stop the power supply immediately.
	Off	The device is not powered on.
ACT	Blink	The system started successfully and is reading and writing data.
	Off	The device is not powered on or does not read and write data.
COM1~COM2	On/Blink	Data is being transmitted.
	Off	The device is not powered on or there is no data transmission.
Yellow indicator of Ethernet port	On	The Ethernet connection is in the normal state.
	Blink	The Ethernet connection is abnormal.
	Off	The Ethernet connection is not set up.
Green indicator of Ethernet port	On	The Ethernet connection is in the normal state.
	Blink	Data is being transmitted over the Ethernet port
	Off	The Ethernet connection is not set up.

1.6 Interface

Introducing the definition and function of each interface in the product.

1.6.1 SD Card Slot

The ED-HMI3020-070C includes a Micro-SD card slot, and the silkscreen is “”, which supports the installation of an SD card for booting the system.

1.6.2 Power Supply

The ED-HMI3020-070C includes one power input, and the silkscreen is “PWR IN”. The connector is USB Type-C, which supports 5V 5A power input.



TIP:

In order for Raspberry Pi 5 to achieve better performance, it is recommended to use a 5V 5A power adapter.

1.6.3 1000M Ethernet

ED-HMI3020-070C includes one adaptive 10/100/1000M Ethernet port, and the silkscreen is “”.

The connector is RJ45, which is used to access to network. It is recommended to use the network cable of Cat6 and above. The pins corresponding to the terminal are defined as follows:

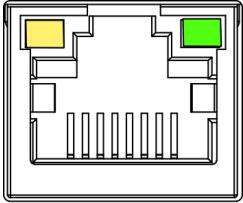
	Pin ID	Pin Name
	1	TX4-
	2	TX4+
	3	TX3-
	4	TX3+
	5	TX2-
	6	TX2+
	7	TX1-
8	TX1+	

1.6.4 HDMI

ED-HMI3020-070C includes 2 HDMI ports, and the silkscreen is "**HDMI**". The connector is micro-HDMI, which can connect to HDMI displays and supports up to 4Kp60.

1.6.5 USB 2.0

ED-HMI3020-070C includes 2 USB 2.0 ports, and the silkscreen is "". The connector is USB Type-A, which can connect to standard USB 2.0 peripherals and supports up to 480Mbps.

1.6.6 USB 3.0

ED-HMI3020-070C includes 2 USB 3.0 ports, and the silkscreen is "". The connector is USB Type-A, which can connect to standard USB 3.0 peripherals and supports up to 5Gbps.

1.6.7 RS232

ED-HMI3020-070C contains 1 RS232 port, 3-Pin 3.5mm spacing phoenix terminals. The silkscreen is "GND/RX/TX".

Pin Definition

Terminal pins are defined as follows:

	Pin ID	Pin Name
	1	GND
	2	RX
	3	TX

The pin names of CM4 corresponding to RS232 interface are as follows:

Signal	CM4 GPIO Name	CM4 Pin Out
TX	GPIO4	UART3_TXD
RX	GPIO5	UART3_RXD

Connecting Cables

Schematic diagram of RS232 wires is as follows:

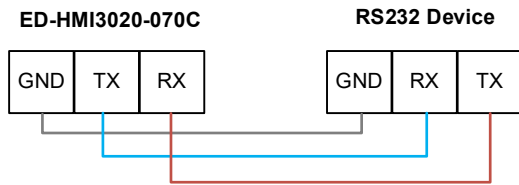

1.6.8 RS485

ED-HMI3020-070C contains 1 RS485 port, 3-Pin 3.5mm spacing phoenix terminals. The silkscreen is "GND/B/A".

Pin Definition

Terminal pins are defined as follows:

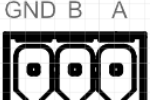
	Pin ID	Pin Name
	1	GND
	2	B
	3	A

The pin names of CM4 corresponding to RS485 interface are as follows:

Signal	CM4 GPIO Name	CM4 Pin Out
A	GPIO12	UART5_TXD
B	GPIO13	UART5_RXD

Connecting Cables

Schematic diagram of RS485 wires is as follows:

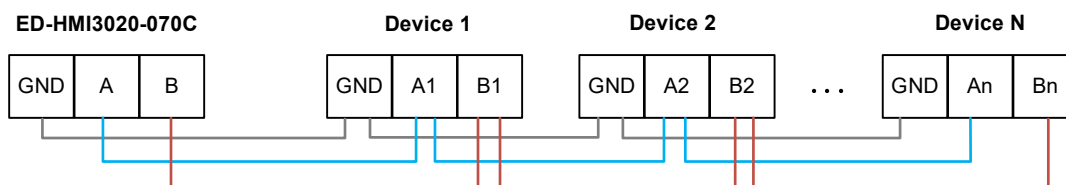

RS485 Terminal Resistor

ED-HMI3020-070C contains a RS485 port. A 120R jumper resistor is reserved between A and B of RS485 line. The jumper cap can be inserted to enable the jumper resistor. By default, the

jumper cap is not connected, and the 120R jumper resistor function is disabled. The position of jumper resistor in the PCBA is J7 in the figure below (red box position).

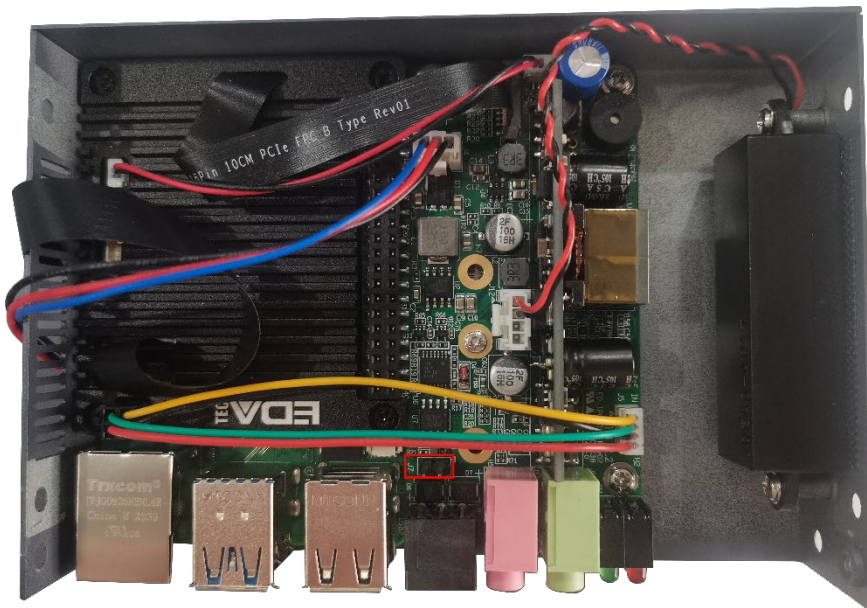

TIP:

You need to open the device case to view the position of 120R jumper resistor. For detailed operations, please refer to [2.3 Open Device Case](#).

1.6.9 Audio In

ED-HMI3020-070C contains one audio input (LINE IN), 3.5mm audio jack connector(red). The silkscreen is “”, supporting stereo audio input.

1.6.10 Audio Out

ED-HMI3020-070C contains one audio output (HPO), 3.5mm audio jack connector(green). The silkscreen is “”, supporting stereo audio output.

1.6.11 Speaker

The ED-HMI3020-070C contains a power amplifier output, built-in a 4Ω 3W speaker, supporting single-channel stereo output. When playing audio, if the headphone is connected to the Audio Out interface (HPO), the speaker will have no audio output.

2 Installing/Removing Components (optional)

This chapter introduces how to install/remove components.

- ✓ Pull Out SD Card
- ✓ Insert SD Card
- ✓ Open Device Case
- ✓ Remove SSD
- ✓ Install SSD
- ✓ Install RTC Battery
- ✓ Close Device Case

2.1 Pull Out SD Card

If you need to remove the SD card while using the product, you can refer to the following instructions.



NOTE:

Please turn off the power before inserting or removing the SD card.

Preparation:

The device has been disconnected from power.

Steps:

1. Find the location of the SD card, as shown in red mark of figure below.



2. Hold the SD card and pull it out.



2.2 Insert SD Card

If the product model includes an SD card, the SD card will be installed by default. If the product model does not include an SD card, you will need to use the SD card later. Please refer to the following to install it.



NOTE:

Please turn off the power before inserting or removing the SD card.

Preparation:

- ◆ SD card is ready.
- ◆ The device has been disconnected from power.

Steps:

1. Find the location of the SD card slot, as shown in red mark of figure below.



2. Insert the SD card into the corresponding card slot with the contact side facing down, making sure it will not fall out.



2.3 Open Device Case

If you need to open the device case while using the product, please refer to the following instructions.

Preparation:

- ◆ A cross screwdriver has been prepared.
- ◆ The device has been disconnected from power.

Steps:

1. Pull out the default configuration of phoenix connector (male for wiring).
2. Use a screwdriver to loosen two M3 screws on two sides counterclockwise, as shown in the red mark of figure below.



3. Remove the front cover to the right, as shown in the figure below.

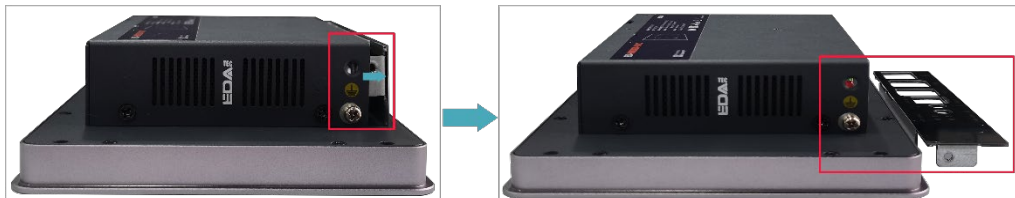

4. Use a screwdriver to loosen four M3 screws and one grounding screw on two sides counterclockwise, as shown in the red mark in the figure below.



5. Remove the metal case upward and flip it clockwise to the PCBA side.

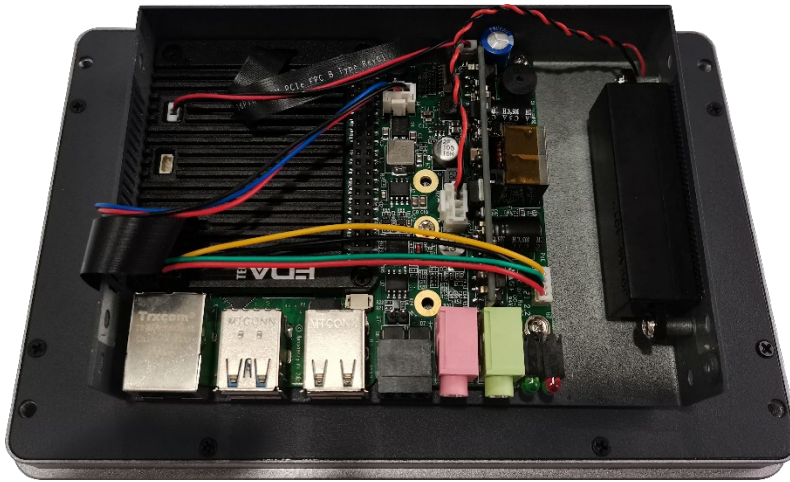

6. Use a screwdriver to loosen 6 screws of PCBA mounting counterclockwise to separate the PCBA from the metal case, and flip it to the back of PCBA.



2.4 Remove SSD

If the SSD is damaged during use and needs to be replaced, the damaged SSD needs to be removed first.

Preparation:

- ◆ The device case has been open.
- ◆ A cross screwdriver has been prepared.

Steps:

1. Find the location of SSD, as shown in the red mark of figure below.

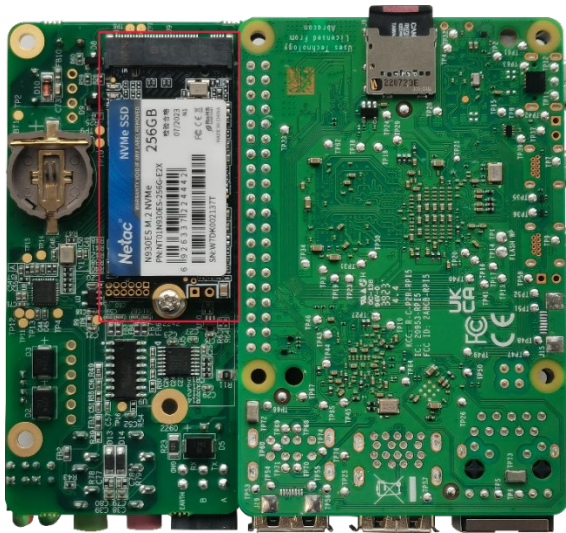

2. Use a screwdriver to loosen the screws that secure the SSD counterclockwise.

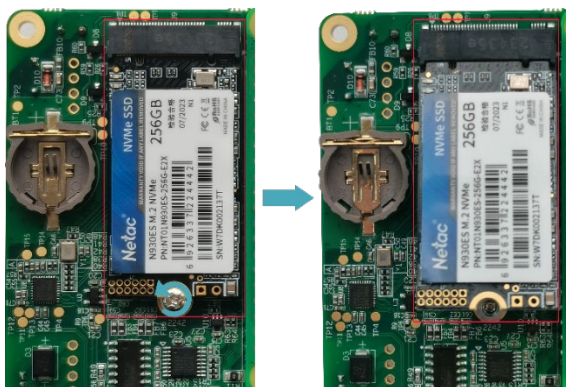

3. Hold both sides of the SSD with your hands and pull it out in the direction of the arrow.

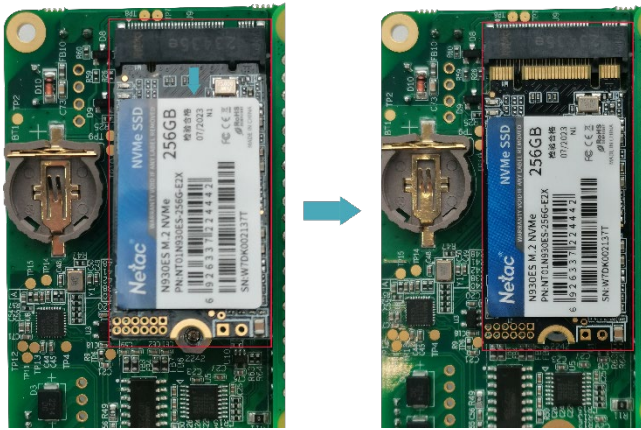

2.5 Install SSD

If you choose a model without SSD when purchasing the product, and you need to use an SSD later, please refer to the following to install the SSD.



TIP:

Only compatible with M.2 2230, M.2 2242 and M.2 2260 SSD.

Preparation:

- ◆ The device case has been open.
- ◆ A cross screwdriver has been prepared.
- ◆ SSD is ready.

Steps:

1. Find the location of SSD connector, as shown in the red mark of figure below.

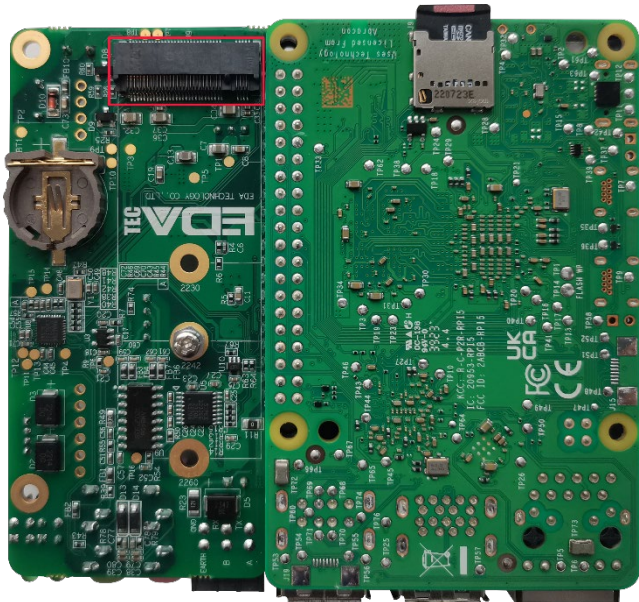

4. Use a screwdriver to loosen the screws that secure the SSD counterclockwise.

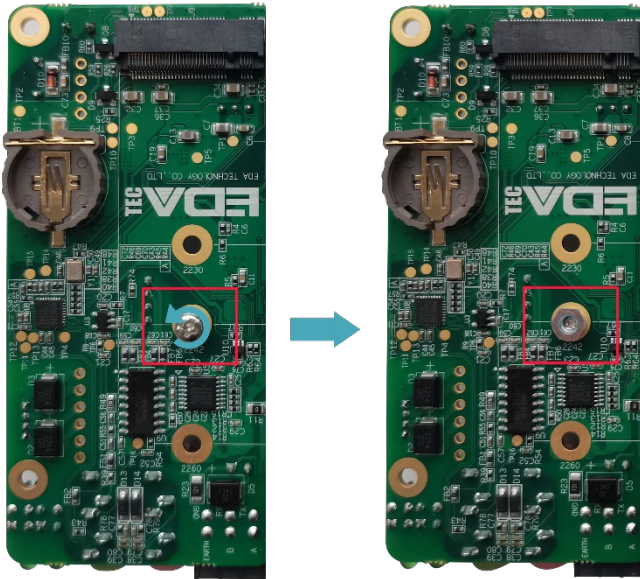

2. Insert the SSD into the connector with the contacts facing up.

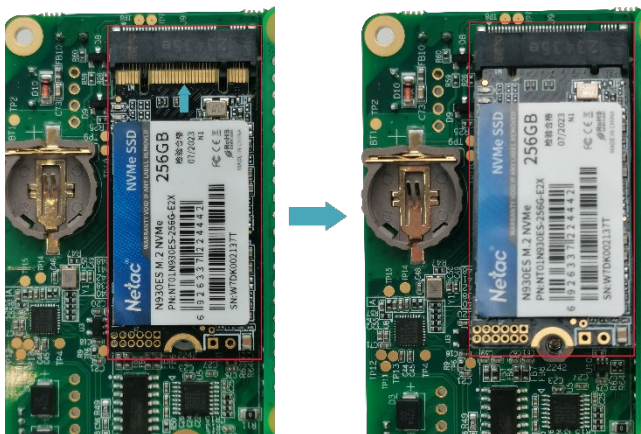

3. Insert the screws that secure the SSD and tighten clockwise to secure the SSD to the PCBA.



2.6 Install RTC Battery



TIP:

Some international logistics do not support the transportation of batteries, and some ex-factory devices are not equipped with CR1220 batteries. Therefore, before using RTC, please prepare a CR1220 battery and install it on the motherboard.

Preparation:

- ◆ The device case has been open.
- The battery CR1220 is ready.

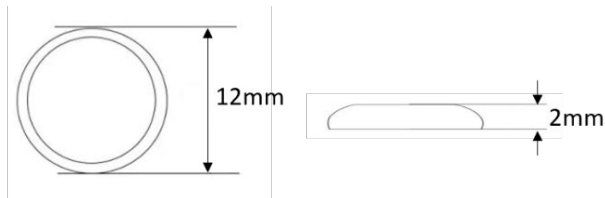

Steps:

1. Find the location of RTC battery base, as shown in the red mark of figure below.

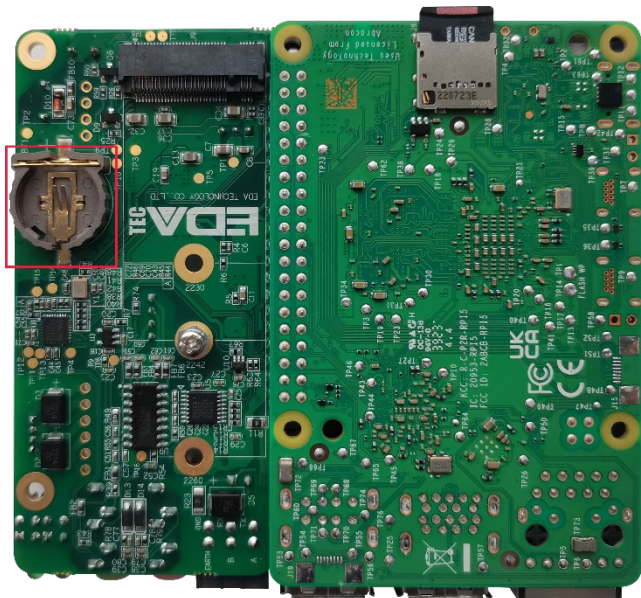

2. Place the positive terminal of the battery facing up, and press it into the RTC base. The completed installation is as shown below.

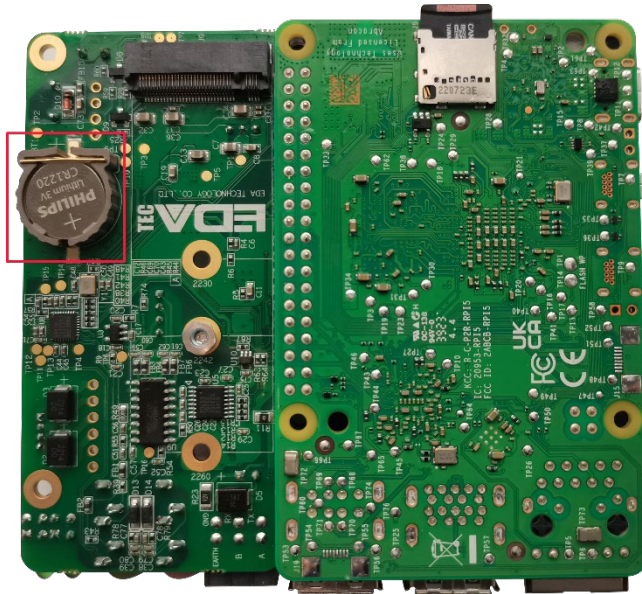

2.7 Close Device Case

Preparation:

A cross screwdriver has been prepared.

Steps:

1. Turn the PCBA over to port side, place the PCBA on the metal case to align the 6 mounting holes on the PCBA with the studs on the metal case. Then insert 6 mounting screws, and tighten clockwise to fix the PCBA to the metal case.

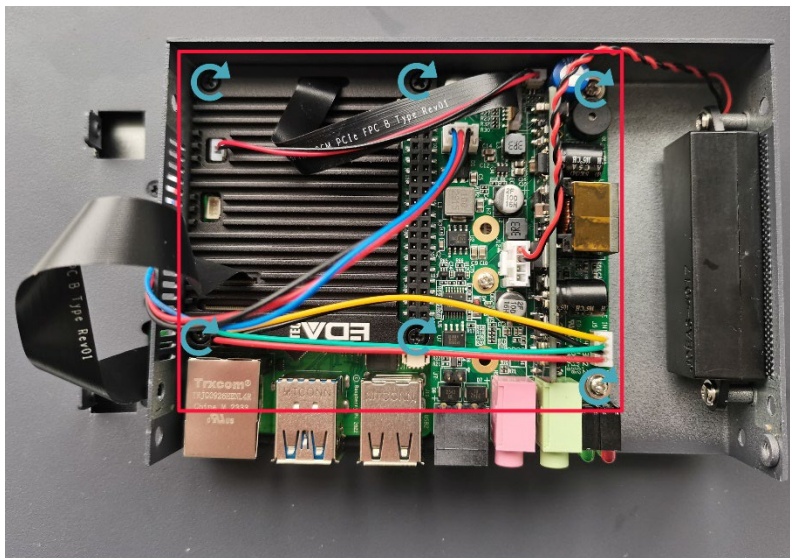

2. Flip the metal case downward, align the screw mounting holes on the metal case with the screw mounting holes on the back of the LCD screen, and cover it downward on the back of the LCD screen.



3. Use a screwdriver to tighten four M3 screws and one grounding screw on two sides clockwise.



4. Align the ports on the PCBA with the port's holes on the side panel, and insert the side cover.



5. Use a screwdriver to tighten 2 M3 screws clockwise to fix the side cover.



6. Plug in the default configuration of phoenix connector.

3 Installing Device

This chapter introduces how to install the device.

- ✓ Embedded Installation

3.1 Embedded Installation

ED-HMI3020-070C supports embedded front installation, which is equipped with 4 buckles (including 4xM4*8 screws and 4xM4*16 screws).

Preparation:

- ◆ The buckles (including 4xM4*8 screws and 4xM4*16 screws) have been obtained from the packaging box.
- ◆ A cross screwdriver has been prepared.

Steps:

1. You need ensure the opening size of the cabinet according to the size of ED-HMI3020-070C, as shown in the figure below.

Unit: mm

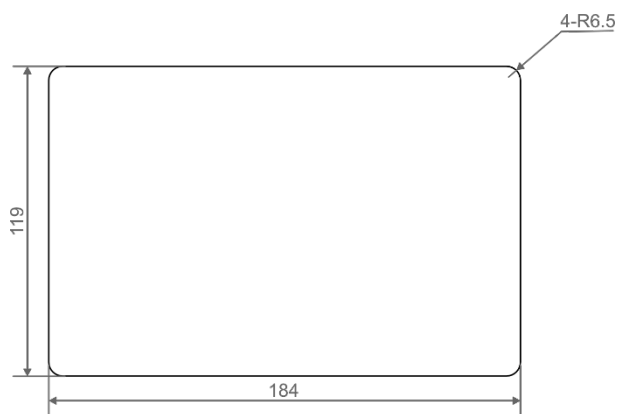

2. Drill a hole on the cabinet according to the hole size of step1.
3. Insert the ED-HMI3020-070C into the cabinet from the outside.

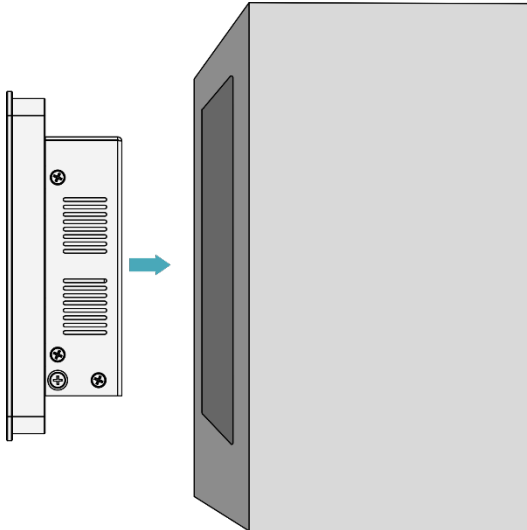

4. Align the screw hole (unthreaded hole) of the buckle with the buckle mounting hole on the side of the device.

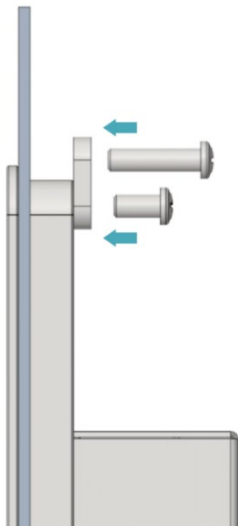

5. Use 4 M4x8 screws to pass through the buckle and tighten it clockwise to fix the buckle to the device; then use 4 M4x16 screws to pass through the screw hole (threaded hole) of the buckle and tighten clockwise to the end through the buckles.

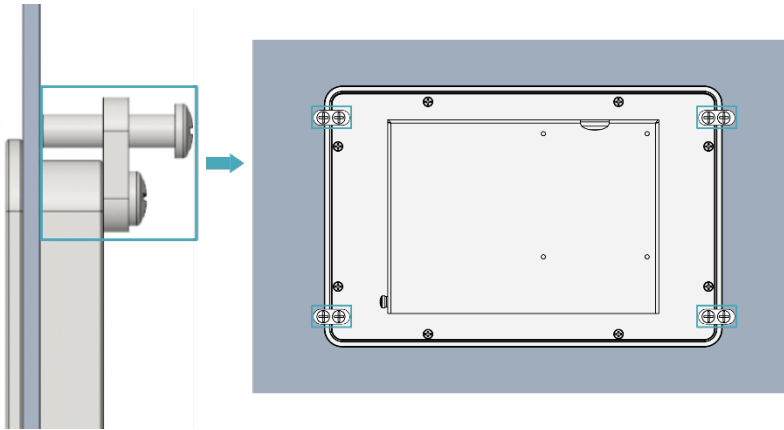

4 Booting The Device

This chapter introduces how to connect cables and boot the device.

- ✓ Connecting Cables
- ✓ Booting The System For The First Time

4.1 Connecting Cables

This section describes how to connect cables.

Preparation:

- ◆ Accessories such as display, mouse, keyboard and power adapter that can be used normally have been ready.
- ◆ A network that can be used normally.
- ◆ Get the HDMI cable and network cable that can be used normally.

Schematic diagram of connecting cables:

Please refer to [1.6 Interface](#) for the pin definition of each interface and the specific method of wiring.

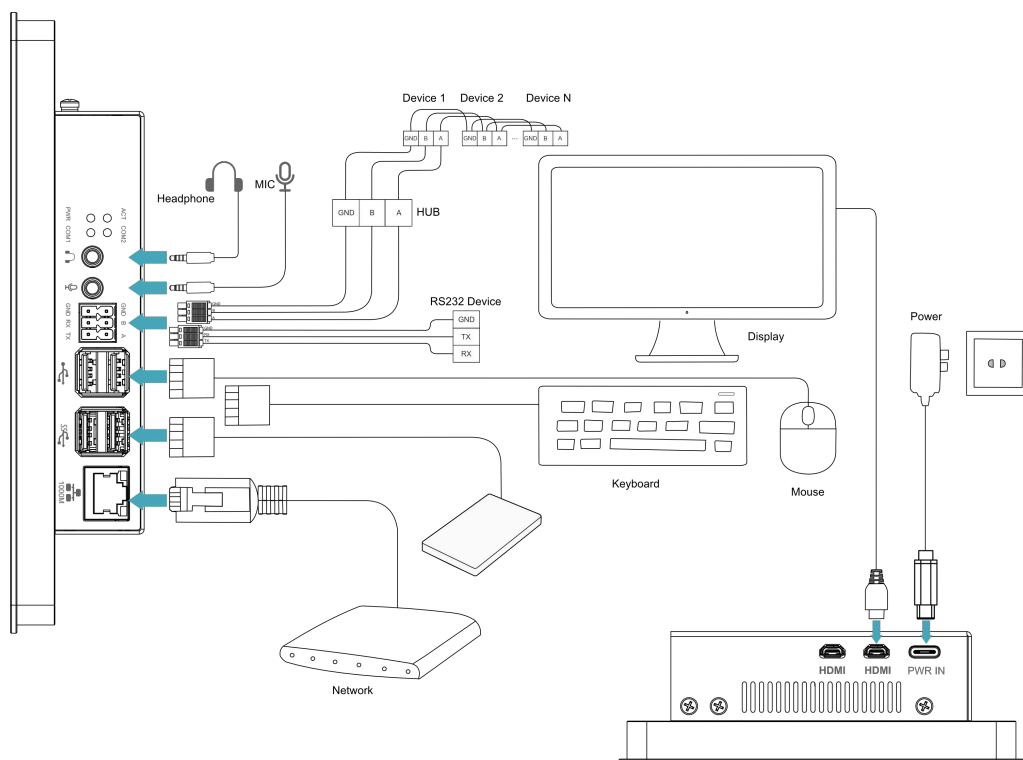

4.2 Booting The System For The First Time

After ED-HMI3020-070C is connected to the power supply, the system will start.

- ◆ The red PWR indicator is on, indicating that the device has been powered normally.
- ◆ The green ACT indicator is blinking, indicating that the system is started normally, and then the logo will appear in the screen.

The product is installed with the Desktop version system when it leaves the factory. After the device is started, it will directly enter the desktop.

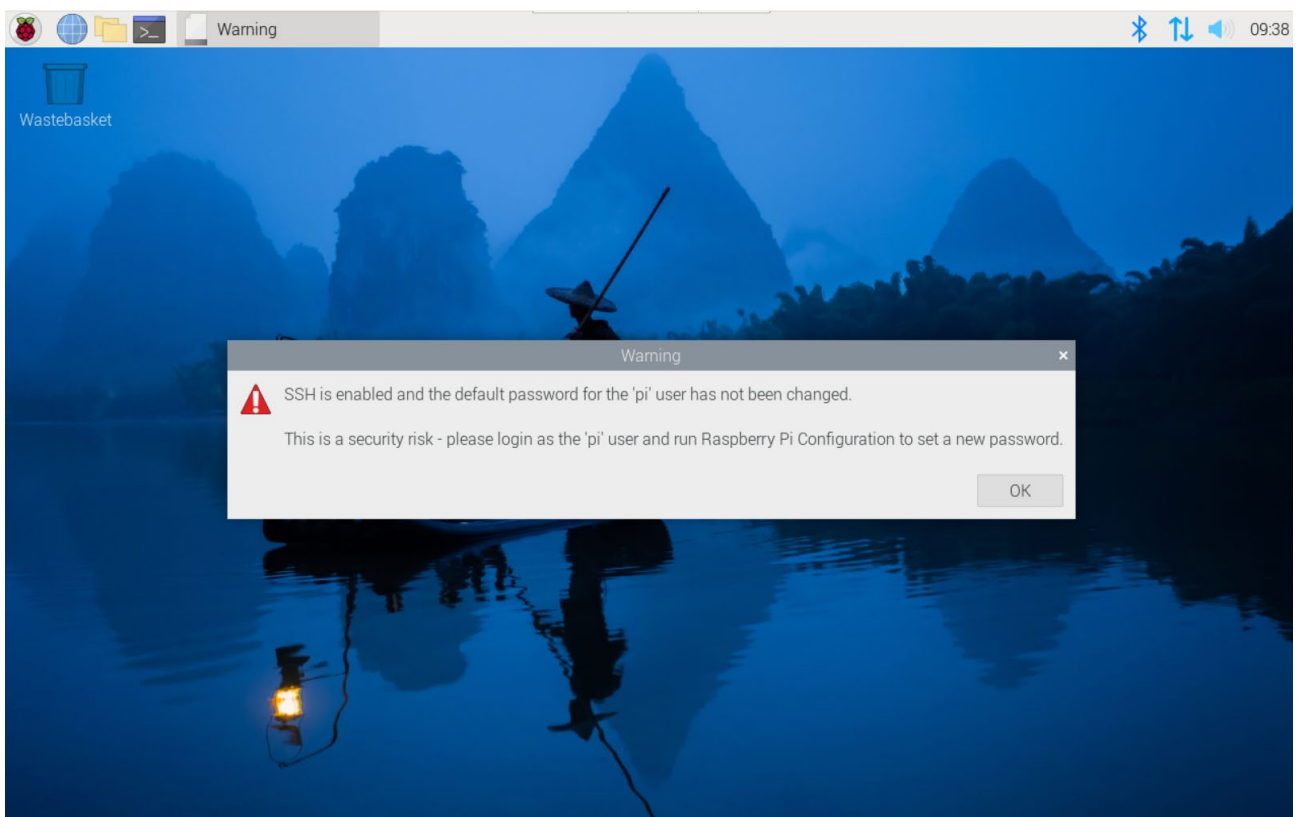

Default username is pi, Default password is raspberry.

5 Configuring System

This chapter introduces how to configure system.

- ✓ Finding Device IP address
- ✓ Remote Login
- ✓ Configuring Wi-Fi
- ✓ Configuring Ethernet IP
- ✓ Configuring Bluetooth
- ✓ Configuring Buzzer
- ✓ Configuring RTC
- ✓ Configuring Serial Port
- ✓ Configuring Audio
- ✓ Configuring SSD (optional)

5.1 Finding Device IP address

In some application scenarios, it is necessary to remotely log in or manage devices, so it is necessary to obtain the device IP address.

5.1.1 View IP address at the Network icon of Desktop

After the device starting normally and the display is connected, you can view the current device IP address at the Network icon.



TIP:

Only supported by Desktop version system.

Preparation:

ED-HMI3020-070C has been connected to the network through the router.

Steps:

Hover over the network icon in the system tray, and a tooltip will appear. This tooltip displays the name of the network you're currently connected to and your IP address.

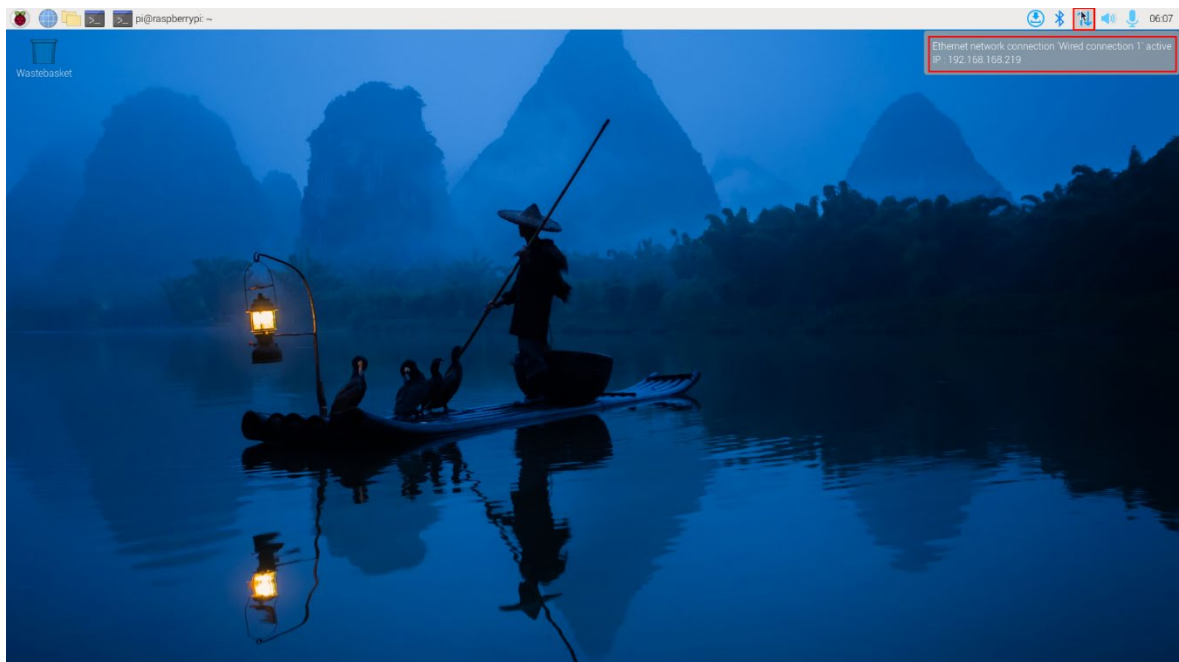

5.1.2 Hostname command to query

After the device starting normally and the display is connected, you can query the current device IP address by using hostname command.

Preparation:

ED-HMI3020-070C has been connected to the network through the router.

Steps:

Run the following command in the command pane to obtain IP address.

hostname -I

```
pi@raspberrypi:~ $ hostname -I  
192.168.168.219
```

5.1.3 Query IP by Using ifconfig Command

After the device is started normally and the display is connected, you can use the ifconfig command to view the current device IP.

Preparation:

ED-HMI3020-070C has been connected to the network through the router.

Steps:

Run the following command in the command pane to view the detailed information of each port of the device, where the inet value in the eth interface is the device IP, as shown in the following figure.

ifconfig

```
pi@raspberrypi:~ $ ifconfig  
eth0: flags=4163<UP,BROADCAST,RUNNING,MULTICAST> mtu 1500  
    inet 192.168.168.219 netmask 255.255.255.0 broadcast 192.168.168.255  
    inet6 fe80::382a:b964:5832:e59a prefixlen 64 scopeid 0x20<link>  
    ether d8:3a:dd:bf:be:c5 txqueuelen 1000 (Ethernet)  
    RX packets 31528594 bytes 5334561751 (4.9 GiB)  
    RX errors 0 dropped 31428512 overruns 0 frame 0  
    TX packets 16597 bytes 12404868 (11.8 MiB)  
    TX errors 0 dropped 0 overruns 0 carrier 0 collisions 0  
    device interrupt 108
```

5.1.4 Query IP by Using Network Manager CLI

After the device is started normally and the display is connected, you can use the built-in Network Manager CLI (nmcli) to view details about your network.

Preparation:

ED-HMI3020-070C has been connected to the network through the router.

Steps:

Run the following command in the command pane to view the detailed network information.

nmcli device show

```

pi@raspberrypi:~$ nmcli device show
GENERAL.DEVICE:                eth0
GENERAL.TYPE:                  ethernet
GENERAL.HWADDR:                D8:3A:DD:BF:BE:C5
GENERAL.MTU:                   1500
GENERAL.STATE:                 100 (connected)
GENERAL.CONNECTION:            Wired connection 1
GENERAL.CON-PATH:              /org/freedesktop/NetworkManager/ActiveConnection/3
WIRED-PROPERTIES.CARRIER:    on
IP4.ADDRESS[1]:                192.168.168.219/24
IP4.GATEWAY:                   192.168.168.1
IP4.ROUTE[1]:                  dst = 192.168.168.0/24, nh = 0.0.0.0, mt = 100
IP4.ROUTE[2]:                  dst = 0.0.0.0/0, nh = 192.168.168.1, mt = 100
IP4.DNS[1]:                    192.168.168.1
IP6.ADDRESS[1]:                fe80::382a:b964:5832:e59a/64
IP6.GATEWAY:                   --
IP6.ROUTE[1]:                  dst = fe80::/64, nh = ::, mt = 1024

```

5.1.5 Login Router to Query IP

When the device starts normally but the display is not connected, you can log in to the router to check the current device IP.

Preparation:

- ◆ ED-HMI3020-070C has been connected to the network through the router.
- ◆ The IP and network password of the router in the network have been obtained, and the IP address is 192.168.X.X.

Steps:

1. Open a browser, Enter the router IP of the network where ED-HMI3020-070C is in the

address bar: 192.168.x.x, and press Enter to enter the router login interface.

2. According to the interface prompts, enter the network password and enter the router management interface.
3. Find the IP address of ED-HMI3020-070C in the terminal device of the management interface.

5.1.6 Scan For Using NMAP Tool

When the device starts normally but the display is not connected, you can use Nmap tool to scan the IP under the current network to obtain the IP information of the device. Nmap supports Linux, macOS, Windows and other platforms.

Preparation:

- ◆ ED-HMI3020-070C has been connected to the network through the router.
- ◆ The IP segment and mask of the router in the network have been obtained, for example, 192.168.X.X/24, where 24 is the subnet mask.

Steps:

For example, using Nmap to scan the network segments from 192.168.3.0 to 255, you can use the following steps:

1. Open the Nmap tool and scan the hosts in the 192.168.X.X/24 network segment.



The Nmap tool operates differently in different operating systems, so please follow the actual interface or command prompts.

2. According to the scanned results, get the device IP of ED-HMI3020-070C.

5.2 Remote Login

There are many remote login methods, and users can choose according to their actual needs. This chapter only introduces SSH and VNC.

5.2.1 Connect To The Device Via SSH

After the device starts normally, you can choose to remotely connect to the device through SSH to configure or debug it.

The tools for remote login are selected by users themselves, and the following is an example of logging in through MobaXterm.

Preparation:

- ◆ The MobaXterm tool has been installed on the PC.
- ◆ ED-HMI3020-070C has been connected to the network through the router.
- ◆ IP address of ED-HMI3020-070C has been get.

Steps:

1. Open MobaXterm, click  Session, and open the window for creating connection, as shown in the figure below.

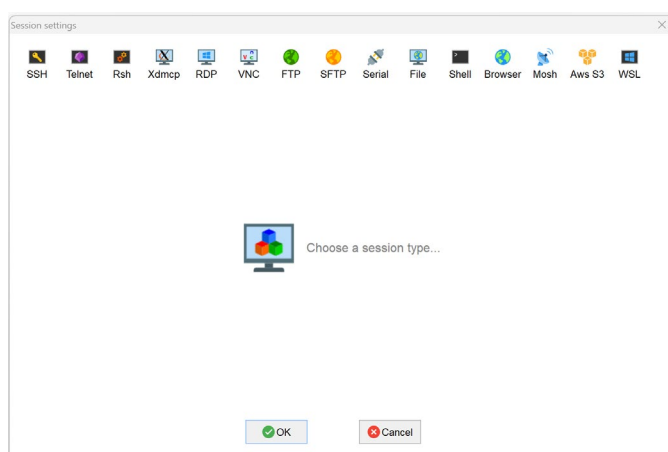

2. Click  SSH, in the upper left corner to open the SSH connection interface.

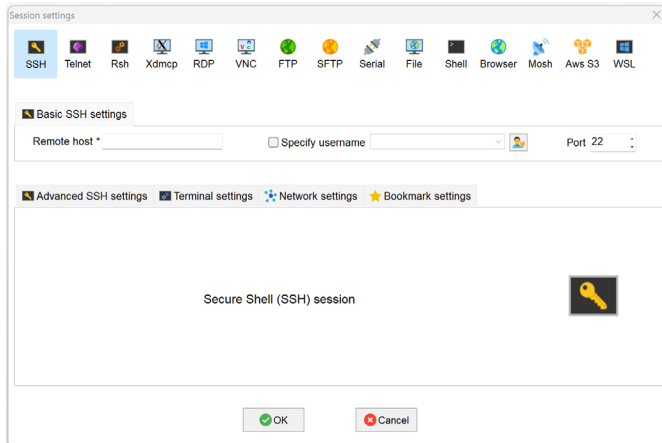

3. After entering the IP address of ED-HMI3020-070C, click "OK".

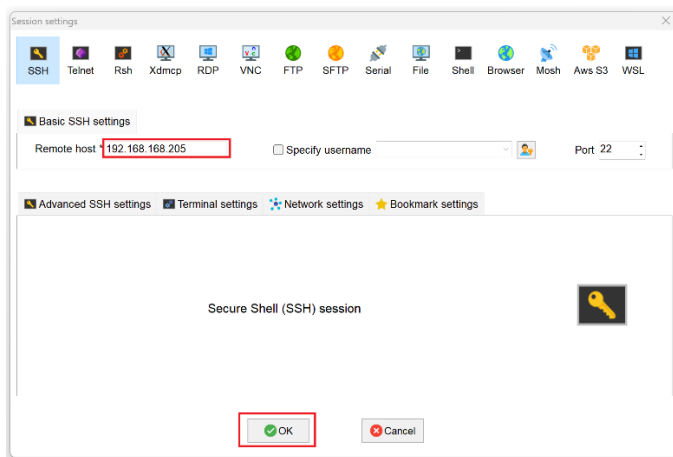

4. Click "Accept" in the pop-up prompt box to enter the system login interface.
5. Enter the username and password according to the prompt, and enter the system after logging in.



TIP:

Default username is pi, Default password is raspberry.

```
login as: pi
pi@192.168.168.205's password:
+ MobaXterm Personal Edition v23.8 +
+ (SSH client, X server and network tools)
+
+ SSH session to pi@192.168.168.205
+ Direct SSH : ✓
+ SSH compression : ✓
+ SSH-browser : ✓
+ X11-forwarding : ✓ (remote display is forwarded through SSH)
+
+ For more info, ctrl+click on help or visit our website.
+
linux raspberrypi 5.10.92-v8+ #1514 SMP PREEMPT Mon Jan 17 17:39:38 GMT 2022 aarch64
The programs included with the Debian GNU/Linux system are free software;
the exact distribution terms for each program are described in the
individual files in /usr/share/doc/*/copyright.
Debian GNU/Linux comes with ABSOLUTELY NO WARRANTY, to the extent
permitted by applicable law.
Last login: Sat May 6 10:07:19 2023 from 192.168.168.227
SSH is enabled and the default password for the 'pi' user has not been changed.
This is a security risk - please login as the 'pi' user and type 'passwd' to set a new password.
pi@raspberrypi:~$
```

5.2.2 Connecting To The Device Desktop Through VNC

After the device starts normally, you can choose to remotely connect to the device through VNC to configure or debug it.

Preparation:

- ◆ The RealVNC Viewer tool has been installed on PC.
- ◆ ED-HMI3020-070C has been connected to the network through the router.
- ◆ IP address of ED-HMI3020-070C has been get.
- ◆ The VNC function in the ED-HMI3020-070C system has been turned on, as shown in the following figure.

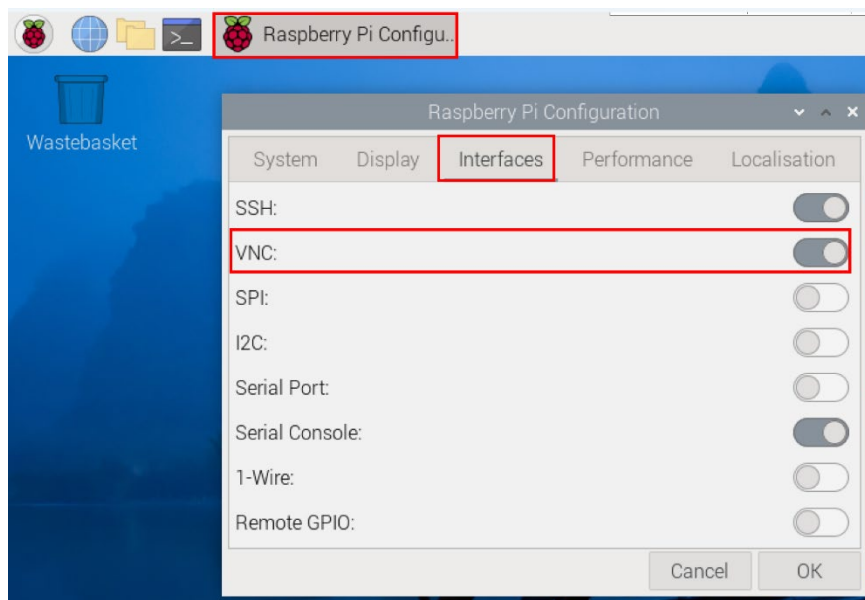

Steps:

1. Open RealVNC Viewer and select "New connection..." in the File in the menu bar to open the window for creating a connection, as shown in the following figure.

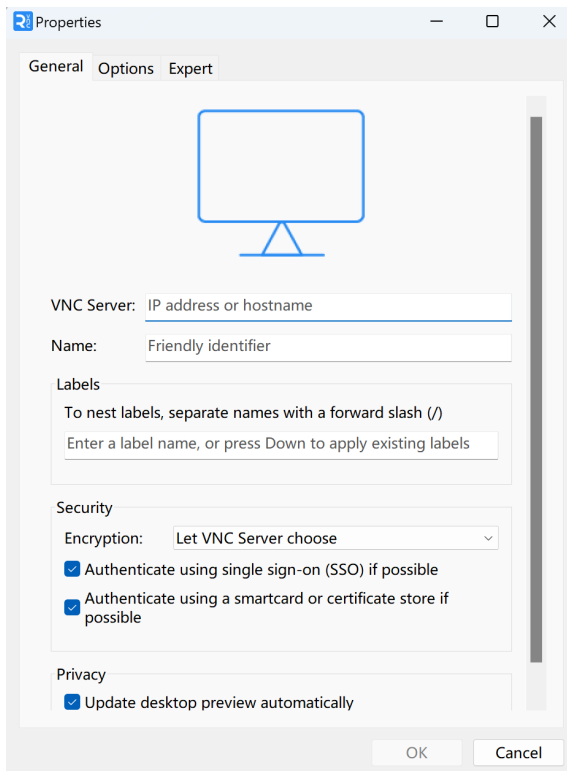

2. After entering the IP address of ED-HMI3020-070C, click "OK".

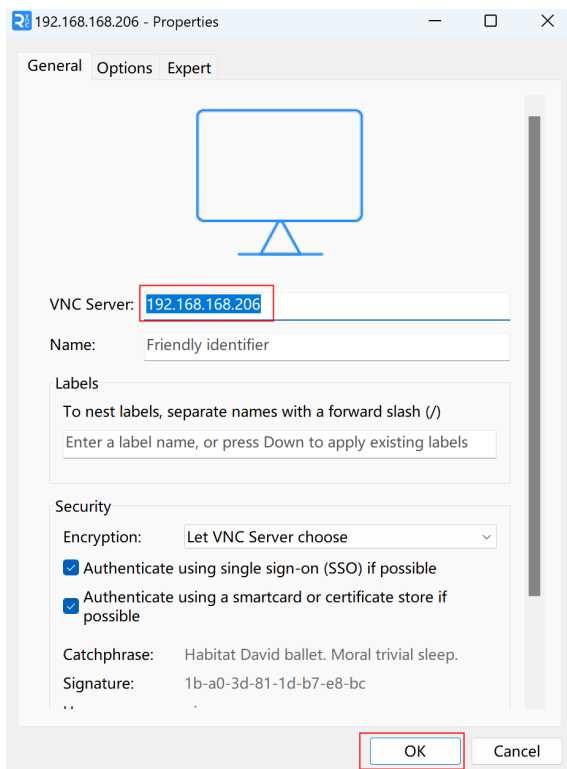

3. Enter the username and password in the Authentication prompt box that pops up.

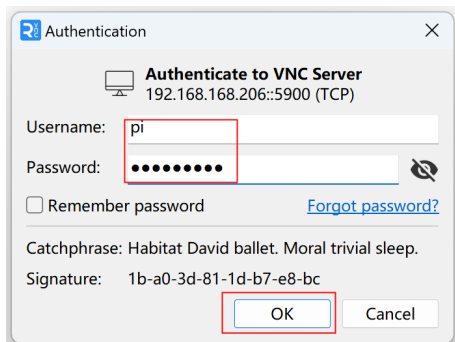
**TIP:****Default username is pi, Default password is raspberry.**

4. Select "OK" to log in and connect to the remote desktop.

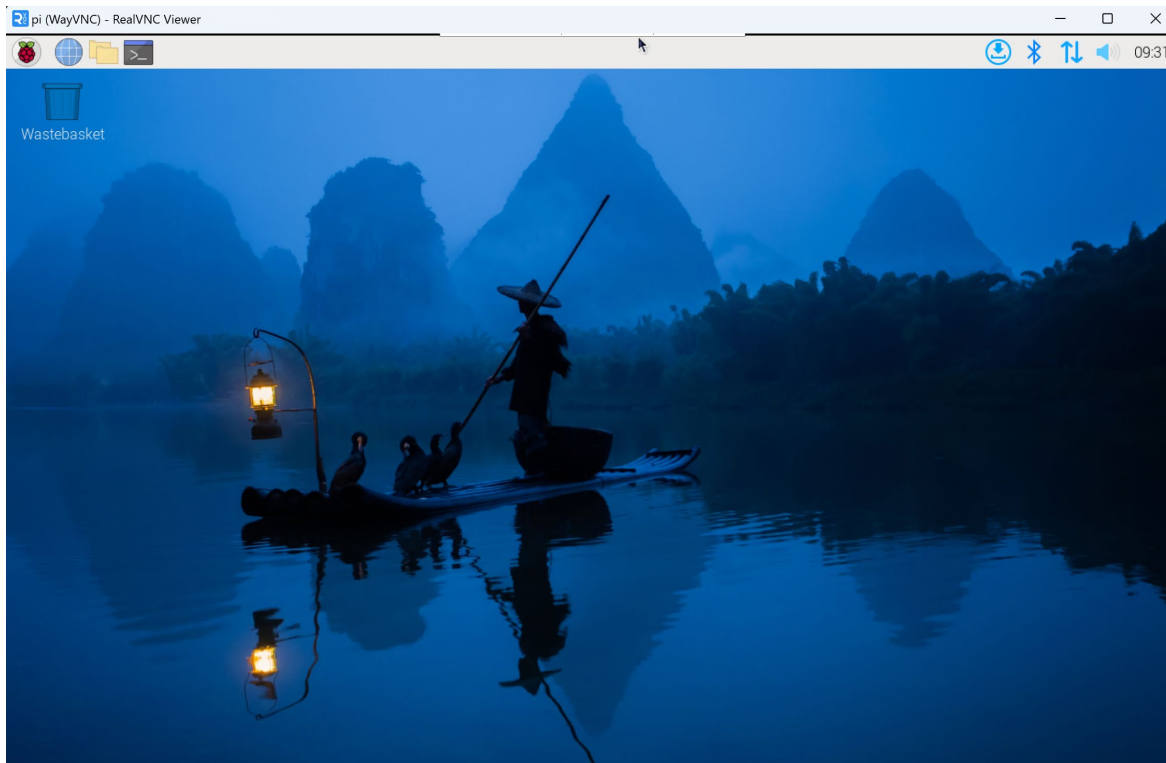

5.3 Configuring Wi-Fi

ED-HMI3020-070C supports Wi-Fi function by default, and you need to configure it before using Wi-Fi.

5.3.1 Enable Wi-Fi

The Wi-Fi function is blocked by default, and you need to set the country region to enable it. You can open the configuration windows through the desktop icon for settings.

Steps:

1. Left-click the icon  in the upper right corner of the desktop and select “Click here to set Wi-Fi country”.

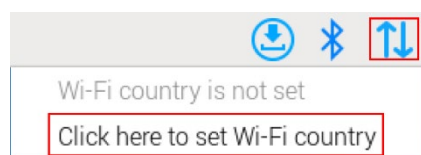

2. Set the value of Country in the pop-up “Wireless LAN Country” pane, and select it according to the actual region.

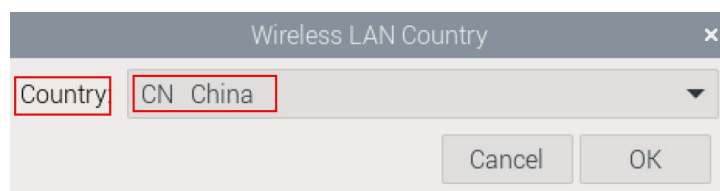

3. Select “OK” to complete the setting.

5.3.2 Configuring Wi-Fi Connection

After enabling the Wi-Fi function, you can connect to Wi-Fi through the desktop icon.

Preparation:

Wi-Fi function is enabled.

Steps:

1. Left-click the icon  in the upper right corner of the desktop, select the Wi-Fi to be connected in the pop-up Wi-Fi list and click it.

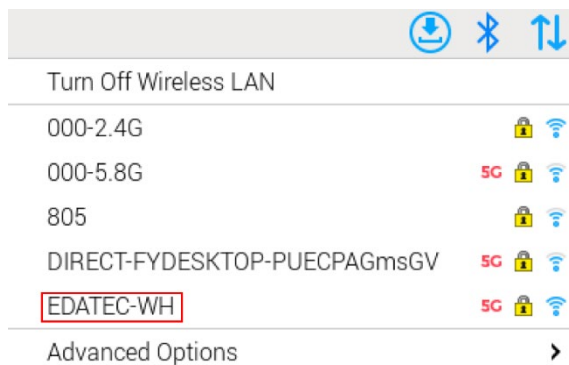

2. Enter the Wi-Fi Password in the pop-up "Wi-Fi Network Authentication Required" pane.



3. Click "Connect" to connect the network. After the connection is completed, the Wi-Fi icon will be displayed normally in the upper right corner of the desktop.

5.4 Configuring Ethernet IP

The IP address is automatically obtained by default. If you need to reconfigure the IP, you can configure it on the desktop.

Preparation:

Wi-Fi function is enabled.

Steps:

1. Left-click the icon  in the upper right corner of the desktop and select "Advanced Options → Edit Connections" in the pop-up menu.

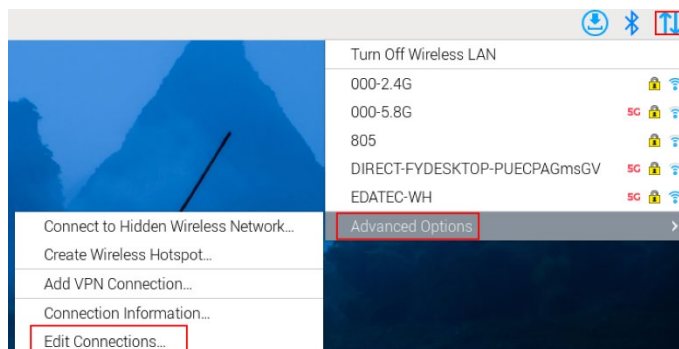

2. In the pop-up "Network Connections" pane, select the connection name to be modified, and then click the Settings button below.

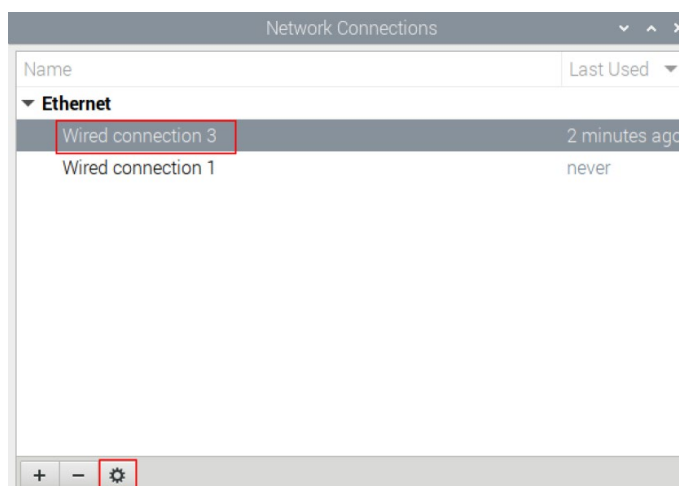

3. In the pop-up "Editing Wired connection" pane, select the "IPv4 Settings" page, and then set the IP address as required.
 - If you want to set the IP as a static IP, set the "Method" as "Manual", add an entry in

Addresses and enter the corresponding IP address information.

Editing Wired connection 3

Connection name: Wired connection 3

General Ethernet 802.1X Security DCB Proxy **IPv4 Settings** IPv6 Settings

Method: Manual

Addresses

Address	Netmask	Gateway	
192.168.168.225	24	192.168.168.1	Add
			Delete

DNS servers:

Search domains:

DHCP client ID:

Require IPv4 addressing for this connection to complete

Routes...

- If you want to set the IP to automatic acquisition mode, you only need to set the "Method" as "Automatic(DHCP)".

Editing Wired connection 3

Connection name: Wired connection 3

General Ethernet 802.1X Security DCB Proxy **IPv4 Settings** IPv6 Settings

Method: Automatic (DHCP)

Additional static addresses

Address	Netmask	Gateway	
			Add
			Delete

Additional DNS servers:

Additional search domains:

DHCP client ID:

Require IPv4 addressing for this connection to complete

Routes...

4. Click "save" to return to "Network Connections" pane and close the page.
5. Execute the **sudo reboot** command to restart the device.

5.5 Configuring Bluetooth

ED-HMI3020-070C supports Bluetooth function, which is enabled by default. You need to finish related configurations such as adding devices, scanning devices and device pairing before using Bluetooth.

Steps:

1. Left-click the icon  in the upper right corner of the desktop and select “Add Device” in the pop-up menu.

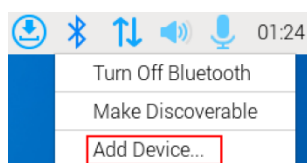

2. In the pop-up "Add New Device" pane, view the scanned Bluetooth devices. Then you can select a Bluetooth device, and click “Pair” to start pairing.

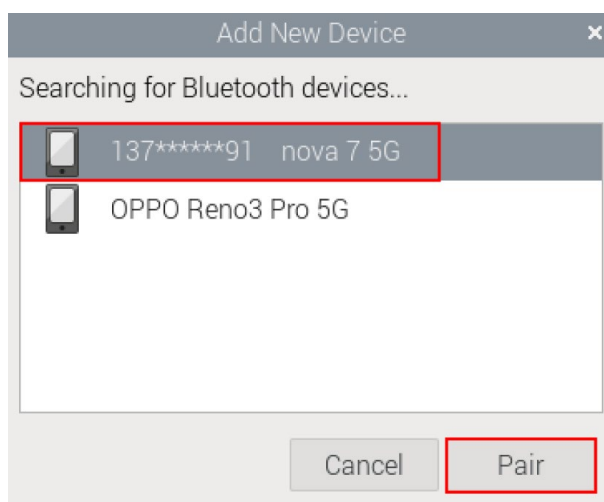

3. Select “OK” in the pop-up prompt box to confirm the pairing request.

Please confirm that '137*****91 nova 7 5G' is showing the code '645999' to pair

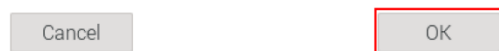

TIP:

You need confirm the pairing request on connected Bluetooth device, otherwise the pairing will fail.

4. After successful Bluetooth pairing, click “OK” in the pop-up prompt to close the page.

5. Left-click the icon  in the upper right corner of the desktop to view the connected Bluetooth device.

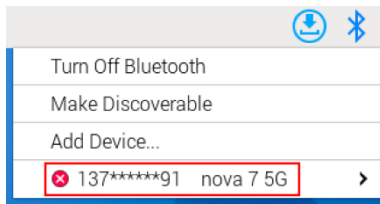

5.6 Configuring Buzzer

ED-HMI3020-070C contains a buzzer, which supports manually configure the buzzer to turn on and off.

1. Execute the following commands to detect and install gpiod tools.

sudo apt update

sudo apt install gpiod

2. Execute the following commands to check the number of gpiochip.

gpiodetect

In the result, the gpiochip of [pinctrl-rp1] (54 lines) is the gpiochip of the buzzer.

3. Execute the following command to turn on and turn off the buzzer.

◆ Turn on the buzzer:

gpioset 4 6=1

- ✓ 4 indicates the number of gpiochip queried in **step 2**.
- ✓ 6 indicates that the controlled gpio pin is GPIO6.
- ✓ 1 indicates the high level.

◆ Turn off the buzzer:

gpioset 4 6=0

- ✓ 4 indicates the number of gpiochip queried in **step 2**.
- ✓ 6 indicates that the controlled gpio pin is GPIO6.
- ✓ 0 indicates the low level.

5.7 Configuring RTC

ED-HMI3020-070C contains an integrated RTC, which automatically reads the system time synchronously by default, and you can manually read and write the system time into RTC.

- ◆ Execute the following command to read the RTC time manually.

sudo hwclock -r

- ◆ Execute the following command to write the system time into RTC.

sudo hwclock -w

5.8 Configuring Serial Port

This chapter introduces the configuration method of RS232 and RS485.

5.8.1 Installing picocom tool

In the Linux environment, you can use the picocom tool to debug the serial ports RS232 and RS485.

Execute the following command to install the picocom tool.

```
sudo apt-get install picocom
```

5.8.2 Configuring RS232

ED-HMI3020-070C contains 1 RS232 port, and its corresponding COM port and device file are detailed in the following table.

Number of RS232 port	Corresponding COM Port	Corresponding Device File
1	COM1	/dev/com1

Preparation:

The RS232 port of ED-HMI3020-070C has been connected with external device.

Steps:

1. Execute the following command to open the serial port com1, and configure the serial port baud rate to 115200.

```
picocom -b 115200 /dev/com1
```

2. Input commands as needed to control external device.

5.8.3 Configuring RS485

ED-HMI3020-070C contains 1 RS485 port, and its corresponding COM port and device file are detailed in the following table.

Number of RS485 port	Corresponding COM Port	Corresponding Device File
1	COM2	/dev/com2

Preparation:

The RS485 port of ED-HMI3020-070C has been connected with external device.

Steps:

1. Execute the following command to open the serial port com2, and configure the serial port baud rate to 115200.

```
picocom -b 115200 /dev/com2
```

2. Input commands as needed to control external device.

5.9 Configuring Audio



ED-HMI3020-070C contains one audio input (supports access to MIC) and one audio output. The volume of Master and MIC can be adjusted, and it supports audio recording of MIC.

5.9.1 Adjusting The Volume

It supports manual adjustment of MIC and Master volume.

- ◆ Adjusting the volume of MIC and Master through desktop icons.

Steps:

1. Click the icon  or , in the upper right corner of the desktop to open the volume adjustment column.



2. Drag the button of the volume adjustment column up and down to adjust the volume, check or uncheck the Mute check box to mute and unmute the audio.

- ◆ Opening the volume adjustment interface through the command line to adjust the volume.

Steps:

1. Execute the following command to open the volume adjustment interface.

alsamixer

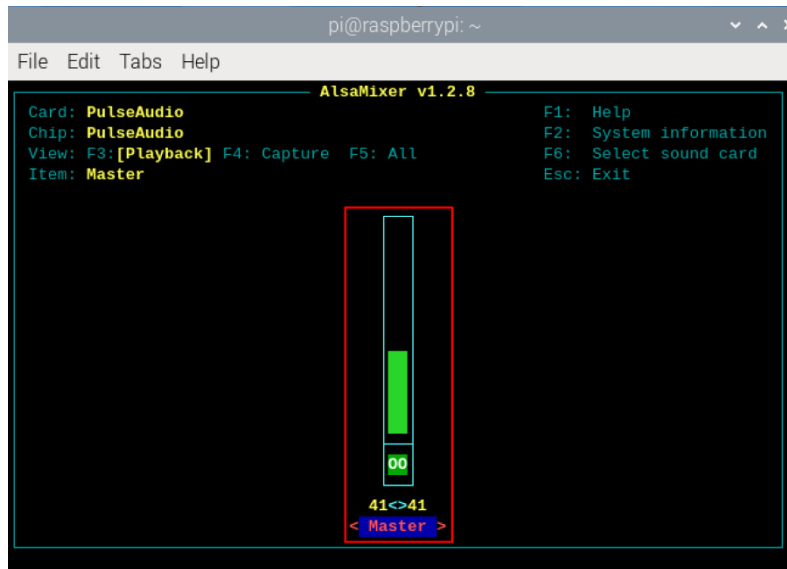

- View the volume value of the current Master in the opened interface. You can adjust the volume through the ↑ key and ↓ key on the keyboard, and press the M key to mute and unmute the audio.

Keyboard Key	Function
↑	Volume+
↓	Volume-
M	Mute or Unmute

5.9.2 Configuring Recording

It supports the audio recording of MIC input.

Preparation:

The audio input interface is connected to the MIC, and the MIC is not muted.

Steps:

- Execute the following command to start recording audio named **name.wav**, as shown in the figure below.

```
arecord -fdat -Dhw:0 --vumeter=stereo name.wav
```

```
pi@raspberrypi:~ $ arecord -fdat -Dhw:0 --vumeter=stereo name.wav
Recording WAVE 'name.wav' : Signed 16 bit Little Endian, Rate 48000 Hz, Stereo
+00%|00%+
```

Parameters	Description
dat	Indicating the audio format, and only supports recording in dat format.
0	Indicating the sound card for recording, it needs to be obtained by executing arecord -l before recording, as shown in the following figure:  <pre> pi@raspberrypi:~ \$ arecord -l **** List of CAPTURE Hardware Devices **** card 0: rt5616codec [rt5616-codec], device 0: 1f000a0000.i2s-rt5616-aif1 rt5616- aif1-0 [1f000a0000.i2s-rt5616-aif1 rt5616-aif1-0] Subdevices: 1/1 Subdevice #0: subdevice #0 </pre>
name.wav	Indicating the recorded file name, which can be customized by the user.

- Input Ctrl+C to save and close the recording.
- Execute the following command to obtain the storage path of the recording file.

pwd

```

pi@raspberrypi:~ $ pwd
/home/pi

```

5.10 Configuring SSD (optional)

ED-HMI3020-070C supports optional SSD. If the product model contains an SSD, you need to finish creating partition, formatting and mounting before using SSD.

5.10.1 Creating Partition

Preparation:

ED-HMI3020-070C contains an SSD.

Steps:

1. Run the following command to view all disk partitions on the ED-HMI3020-070C.

```
sudo lsblk -o UUID,NAME,FSTYPE,SIZE,MOUNTPOINT,LABEL,MODEL
```

After running the command, the information displayed is as follows:

In the figure, the disk whose “NAME” is “nvme0n1” indicates the SSD. As can be seen from the figure below, the SSD is not partitioned.

```
pi@raspberrypi:~$ sudo lsblk -o UUID,NAME,FSTYPE,SIZE,MOUNTPOINT,LABEL,MODEL
UUID                                NAME      FSTYPE  SIZE MOUNTPOINT  LABEL  MODEL
16F4-8888                            mmcblk0   28.8G
├── mmcblk0p1 vfat      512M /boot/firmware bootfs
└── mmcblk0p2 ext4      28.3G /          rootfs
a517c25c-9cce-431b-9594-1cced3f0e02f nvme0n1   119.2G
```

- UUID, NAME, FSTYPE, SIZE, MOUNTPOINT, LABEL and MODEL are disk parameters that need to be listed.
 - The types of MOUNTPOINT are “/” and “/boot”.
 - LABEL is the corresponding disk model.
 - FSTYPE indicates the file system type contained.
2. Run the following command to create a partition for the SSD.

```
sudo fdisk /dev/nvme0n1
```

Set the partition parameters according to the prompts:

```

pi@raspberrypi:~$ sudo fdisk /dev/nvme0n1

Welcome to fdisk (util-linux 2.38.1).
Changes will remain in memory only, until you decide to write them.
Be careful before using the write command.

Device does not contain a recognized partition table.
Created a new DOS (MBR) disklabel with disk identifier 0x5153cfa3.

Command (m for help): n
Partition type
   p   primary (0 primary, 0 extended, 4 free)
   e   extended (container for logical partitions)
Select (default p):

Using default response p.
Partition number (1-4, default 1):
First sector (2048-1000215215, default 2048):
Last sector, +/-sectors or +/-size{K,M,G,T,P} (2048-1000215215, default 1000215215):

Created a new partition 1 of type 'Linux' and of size 476.9 GiB.

Command (m for help): w
The partition table has been altered.
Calling ioctl() to re-read partition table.
Syncing disks.

```

3. Run the following command to check whether the partition is created successfully.

lsblk

```

pi@raspberrypi:~$ lsblk
NAME        MAJ:MIN RM  SIZE RO TYPE MOUNTPOINTS
mmcblk0     179:0   0  28.8G  0 disk
├─mmcblk0p1 179:1   0   512M  0 part /boot/firmware
└─mmcblk0p2 179:2   0   28.3G  0 part /
nvme0n1     259:0   0 119.2G  0 disk
└─nvme0n1p1 259:1   0 119.2G  0 part

```

- ✓ After executing the command, if the “TYPE” column displays “part”, it means that the partition is successful.
- ✓ After executing the command, if the “TYPE” column does not display “part”, it means that the partition is failed.

5.10.2 Formatting

The SSD of ED-HMI3020-070C by default is not formatted. After the disk partition is completed, it needs to be formatted into ext4 format.

Preparation:

Disk partitioning of SSD has been completed.

Steps:

Execute the following command to format the SSD named **nvme0n1p1** into ext4 format.

sudo mkfs.ext4 /dev/nvme0n1p1

```
pi@raspberrypi:~$ sudo mkfs.ext4 /dev/nvme0n1p1
mke2fs 1.47.0 (5-Feb-2023)
Discarding device blocks: done
Creating filesystem with 31258452 4k blocks and 7815168 inodes
Filesystem UUID: 6d7e7a27-a2f9-4f04-b209-8e85ddef767f
Superblock backups stored on blocks:
    32768, 98304, 163840, 229376, 294912, 819200, 884736, 1605632, 2654208,
    4096000, 7962624, 11239424, 20480000, 23887872

Allocating group tables: done
Writing inode tables: done
Creating journal (131072 blocks): done
Writing superblocks and filesystem accounting information: done
```

5.10.3 Mounting SSD

The SSD of ED-HMI3020-070C by default needs to be configured to mount SSD in a specific folder, usually in the “/mnt” folder (such as “/mnt/SSD”).

Preparation:

Partitioning and formatting of the SSD have been completed.

Steps:

1. Run the following command to view all disk partitions on the ED-HMI3020-070C.

sudo lsblk -o UUID,NAME,FSTYPE,SIZE,MOUNTPOINT,LABEL,MODEL

After running the command, the information displayed is as follows:

In the figure, the disk whose “NAME” is “nvme0n1p1” indicates the SSD to be mounted.

```
pi@raspberrypi:~$ sudo lsblk -o UUID,NAME,FSTYPE,SIZE,MOUNTPOINT,LABEL,MODEL
UUID                                NAME      FSTYPE  SIZE MOUNTPOINT  LABEL  MODEL
16F4-8888                            mmcblk0          28.8G
a517c25c-9cce-431b-9594-1cced3f0e02f  └-mmcblk0p1 vfat     512M /boot/firmware bootfs
6d7e7a27-a2f9-4f04-b209-8e85ddef767f  └-mmcblk0p2 ext4     28.3G /          rootfs
6d7e7a27-a2f9-4f04-b209-8e85ddef767f  nvme0n1          119.2G
6d7e7a27-a2f9-4f04-b209-8e85ddef767f  └-nvme0n1p1 ext4    119.2G NS128GSSD510
```

- UUID, NAME, FSTYPE, SIZE, MOUNTPOINT, LABEL and MODEL are disk parameters that need to be listed.

- The types of MOUNTPOINT are “/” and “/boot”.
 - LABEL is the corresponding disk model.
 - FSTYPE indicates the file system type contained.
2. Run the following command to obtain the location of disk partition.

sudo blkid

After executing the command, the following information is displayed, which the SSD partition is displayed as “/dev/nvme0n1p1”.

```
pi@raspberrypi:~$ sudo blkid
/dev/mmcblk0p1: LABEL_FATBOOT="bootfs" LABEL="bootfs" UUID="16F4-8888" BLOCK_SIZE="512" TYPE="vfat" PARTUUID="f438352b-01"
/dev/mmcblk0p2: LABEL="rootfs" UUID="a517c25c-9cce-431b-9594-1cced3f0e02f" BLOCK_SIZE="4096" TYPE="ext4" PARTUUID="f438352b-02"
/dev/nvme0n1p1: UUID="6d7e7a27-a2f9-4f04-b209-8e85ddf767f" BLOCK_SIZE="4096" TYPE="ext4" PARTUUID="da830e78-01"
```

3. Create a target folder as the mount point of SSD. Assuming that the mount name is SSD and the directory to be mounted is “/mnt”, the command to be executed is as follows:

```
sudo mkdir /mnt/SSD
```

4. Mount the SSD at the created mount point, and execute the following command:

```
sudo mount /dev/nvme0n1p1 /mnt/SSD
```

5. Run the following command to check whether the SSD is mounted successfully.

lsblk

```
pi@raspberrypi:~$ lsblk
NAME        MAJ:MIN RM  SIZE RO TYPE MOUNTPOINTS
mmcblk0     179:0    0  28.8G  0 disk
├─mmcblk0p1 179:1    0   512M  0 part /boot/firmware
└─mmcblk0p2 179:2    0  28.3G  0 part /
nvme0n1     259:0    0 119.2G  0 disk
└─nvme0n1p1 259:1    0 119.2G  0 part /mnt/SSD
```

- ✓ After executing the command, if the display information lists the mount point “/mnt/SSD”, it means the mount of SSD is successful.
- ✓ After executing the command, if the displayed information does not list the mount point information, it means that the mount of SSD is failed.